

Year 2 – Maths

Complete the following in your homework book.

a) Look at the balance scale. What is the mass of the strawberries?

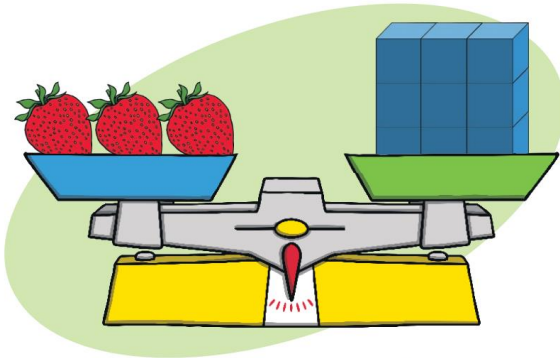

blocks

b) What is the mass of one strawberry?

blocks

Look at the picture and tick the sentence that is correct.

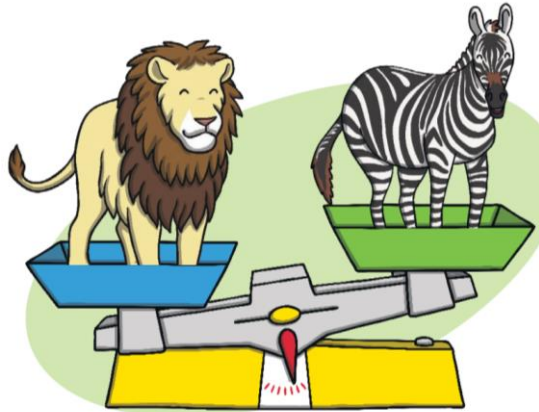

The lion and the zebra weigh the same.

The lion is lighter than the zebra.

The zebra is lighter than the lion.

Lucy is measuring the mass of the glue stick in cubes. Can you explain her mistake?

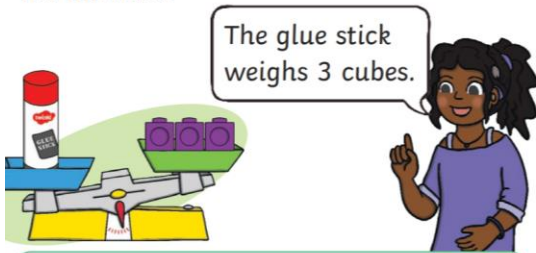

Match each clock to the correct time.



5 o'clock

half past 5

half past 6

Circle the month of the year that comes **before** May and **after** March.

April June August December

Draw the hands on each clock face to show each time.

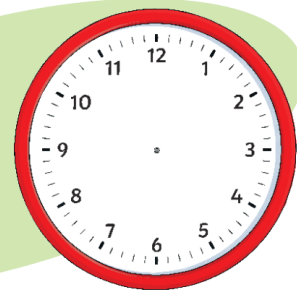
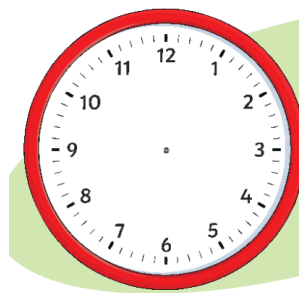

3 o'clock

half past 3

Light or Heavy?

Tick the object that is heaviest.

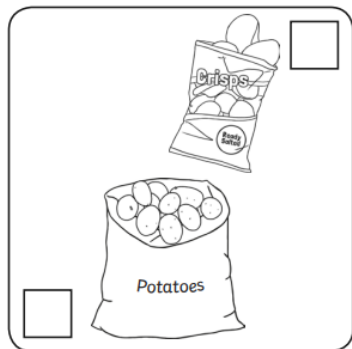
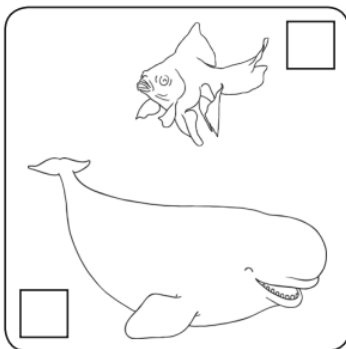
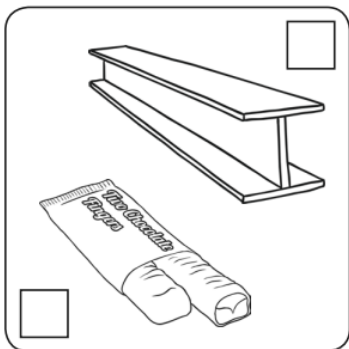
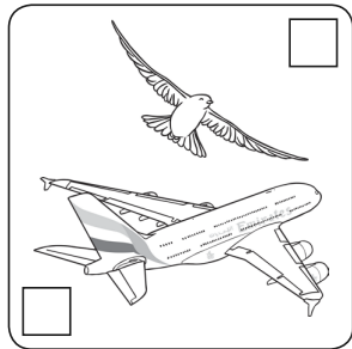
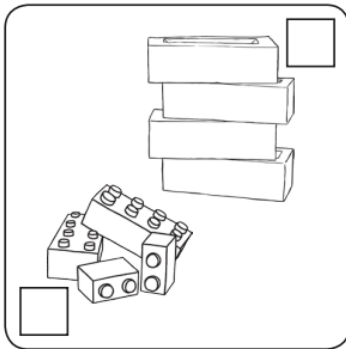
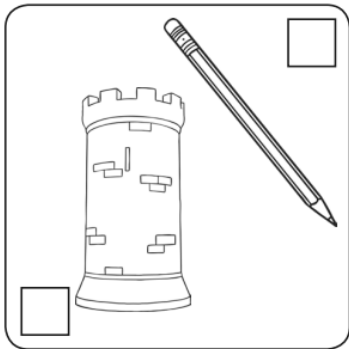
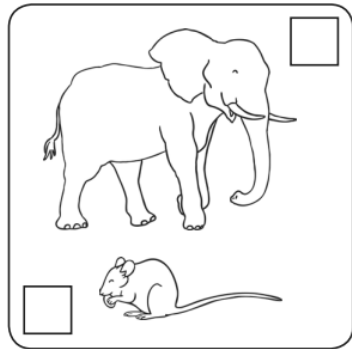
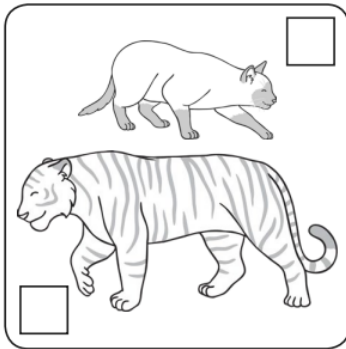
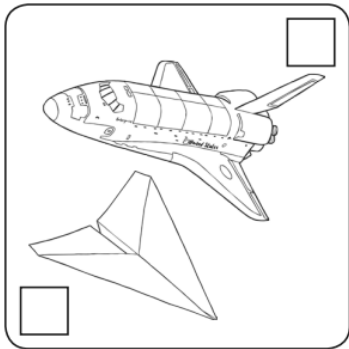

Match the Mass with Marbles

Draw the marbles to make the balance scales true.

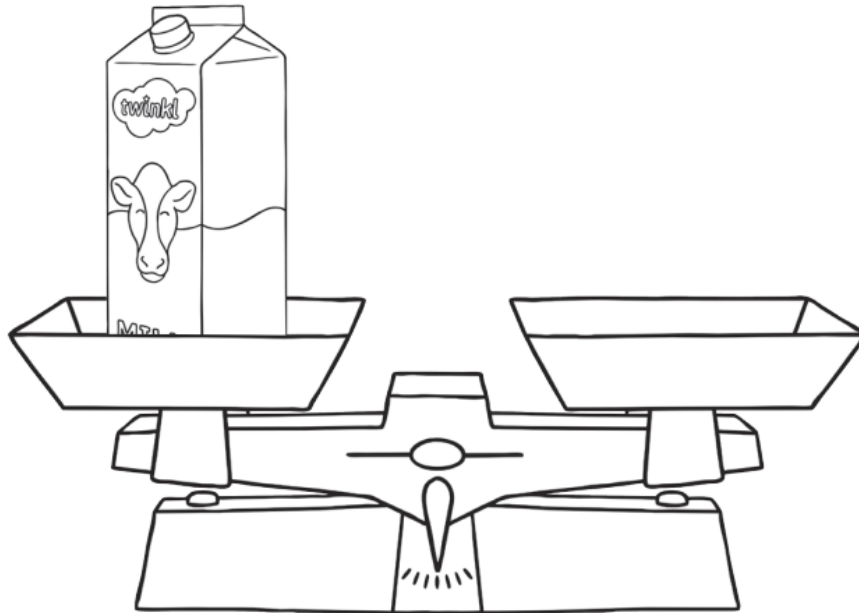

The carton of milk weighs 12 marbles

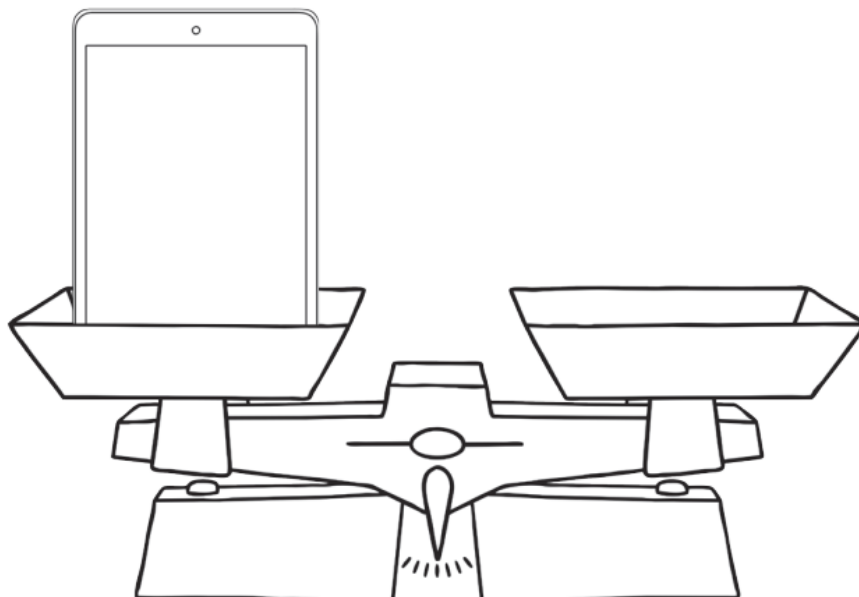

The tablet weighs 18 marbles.