

# Perimeter

I am learning to calculate the perimeter of shapes.

Calculate the perimeter of each of these shapes. Write the answer inside the shape. Always check the units of measure and remember that these drawings are not to scale!

1)

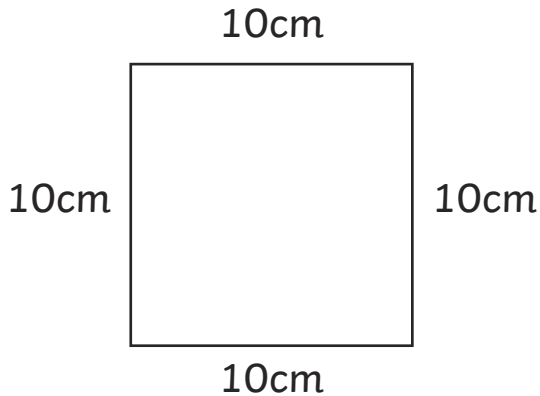

2)

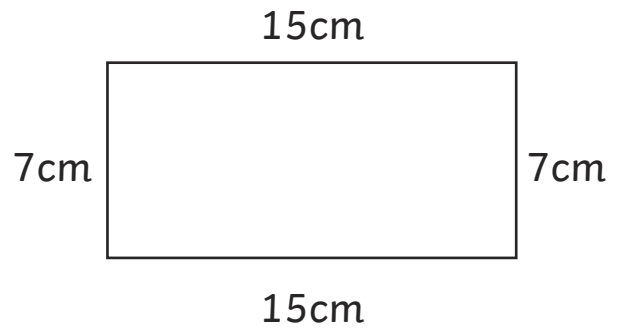

3)

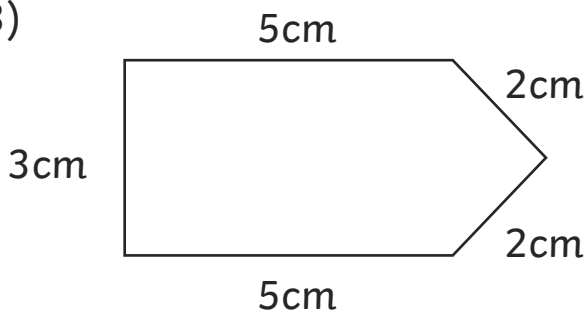

4)

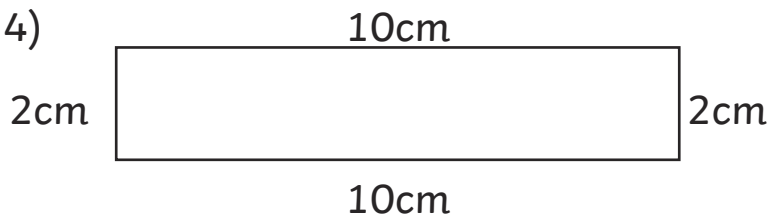

5)

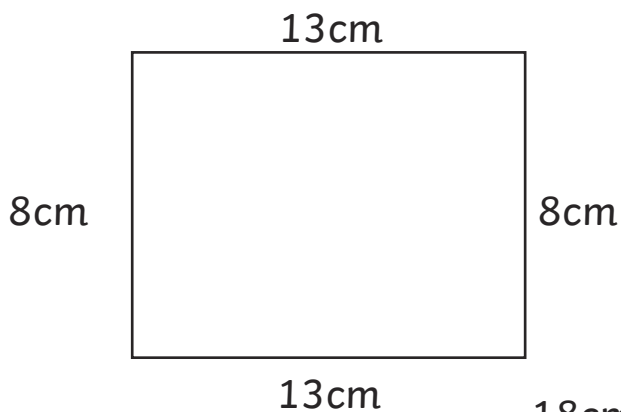

6)

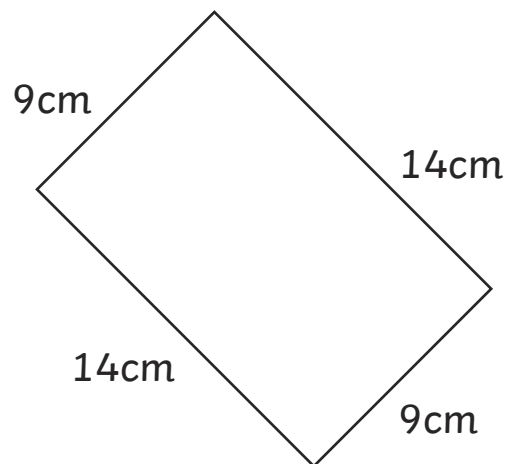

7)

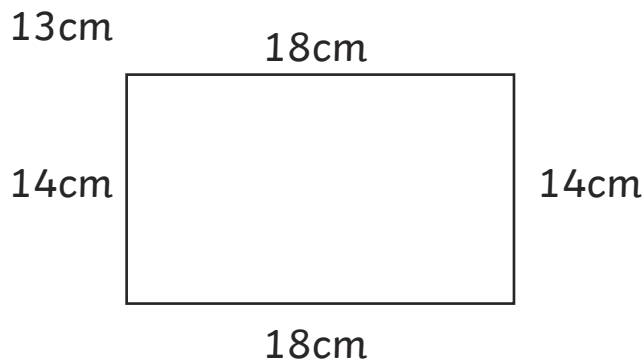

# Perimeter

I am learning to calculate the perimeter of shapes.

Calculate the perimeter of each of these shapes. Write the answer inside the shape. Always check the units of measure and remember that these drawings are not to scale!

1)

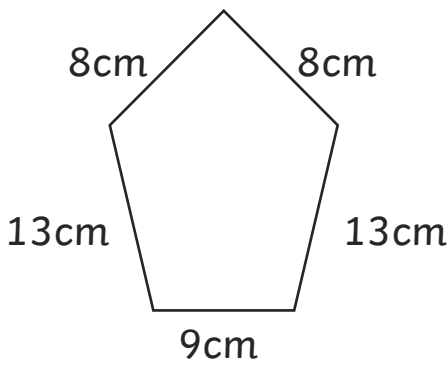

2)

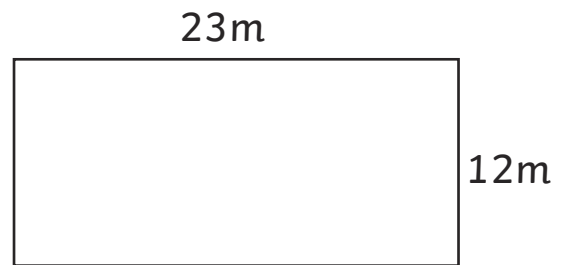

3)

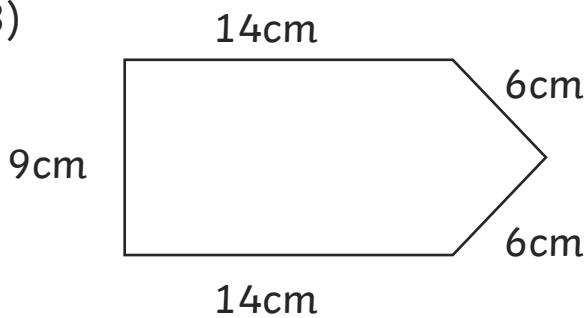

4)

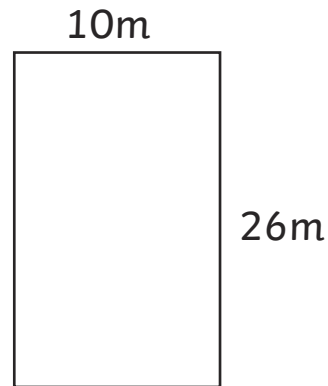

5)

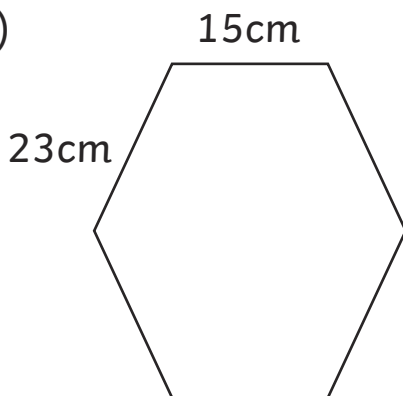

6)

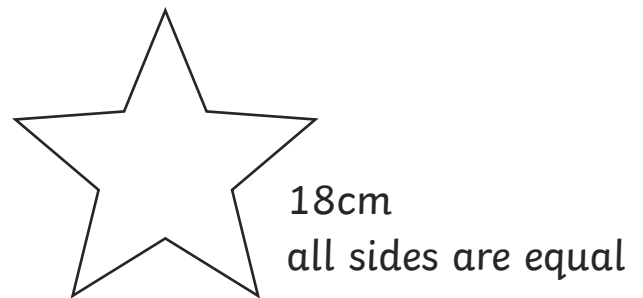

7)

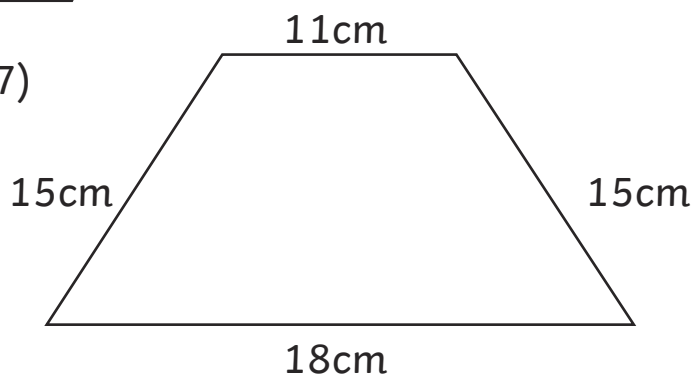

# Perimeter

I am learning to calculate the perimeter of shapes.

Calculate the perimeter of each of these shapes. Write the answer inside the shape. Always check the units of measure and remember that these drawings are not to scale!

