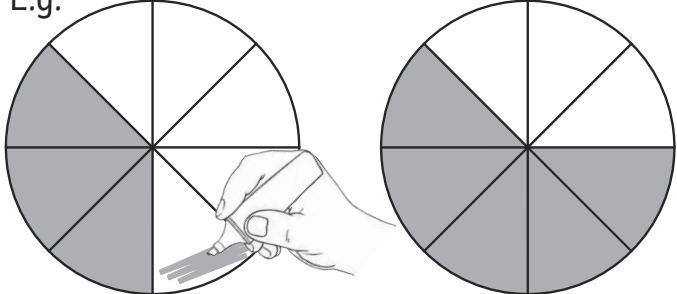
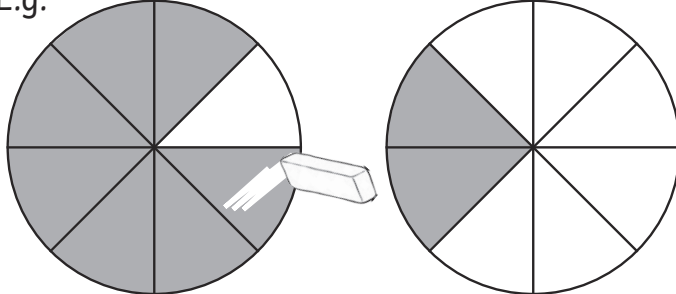
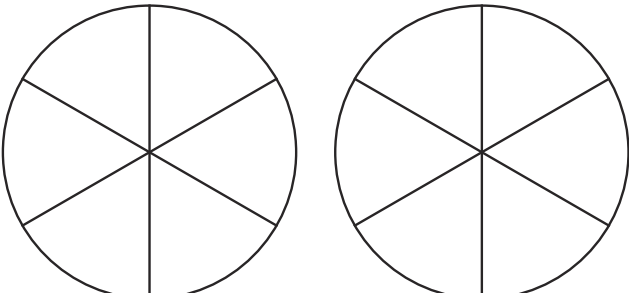
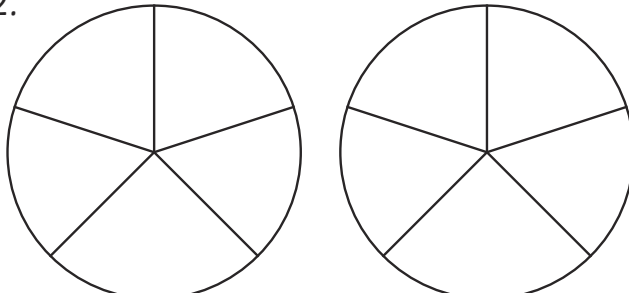
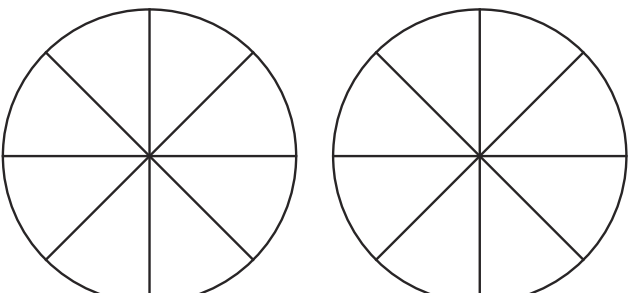
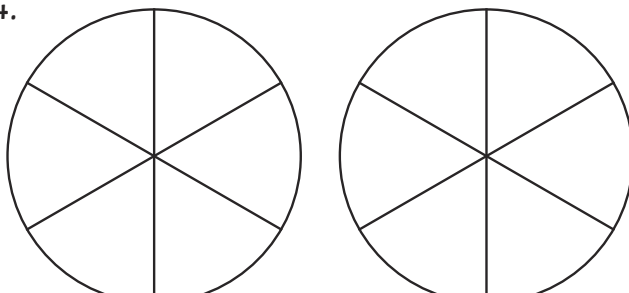

# Adding and subtracting fractions with the same denominator

Colour the correct number of sections in each circle, and then colour more or erase some depending on the calculation. The denominator stays the same – you just have more or less sections depending on the calculation!

<p>E.g.</p>  <p><math>\frac{3}{8} + \frac{2}{8} =</math></p> <p><math>\frac{5}{8}</math></p>	<p>E.g.</p>  <p><math>\frac{7}{8} - \frac{5}{8} =</math></p> <p><math>\frac{2}{8}</math></p>
--	--

<p>1.</p>  <p><math>\frac{2}{6} + \frac{2}{6} =</math></p> <p>—</p>	<p>2.</p>  <p><math>\frac{4}{5} - \frac{3}{5} =</math></p> <p>—</p>
--	---

<p>3.</p>  <p><math>\frac{1}{8} + \frac{4}{8} =</math></p> <p>—</p>	<p>4.</p>  <p><math>\frac{5}{6} - \frac{2}{6} =</math></p> <p>—</p>
--	---

5.

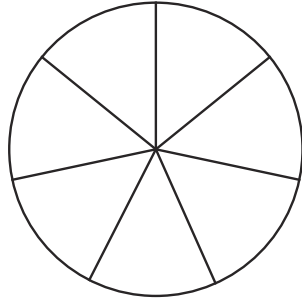
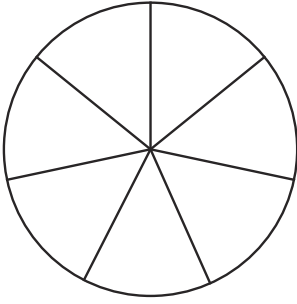

$$\frac{2}{7} + \frac{3}{7} =$$

—

6.

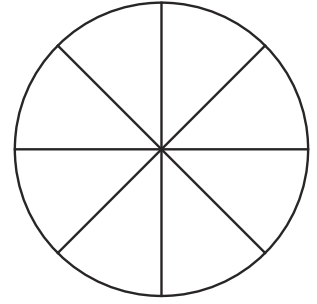
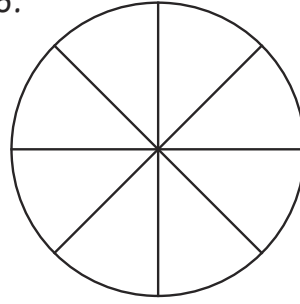

$$\frac{8}{8} - \frac{7}{8} =$$

—

7.

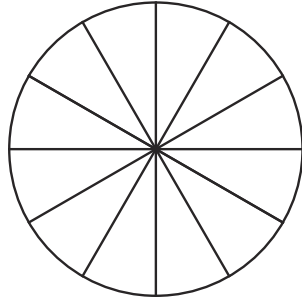
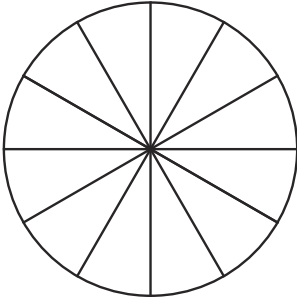

$$\frac{2}{12} + \frac{8}{12} =$$

—

8.

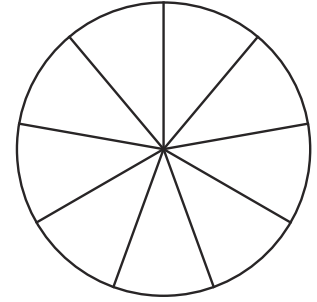
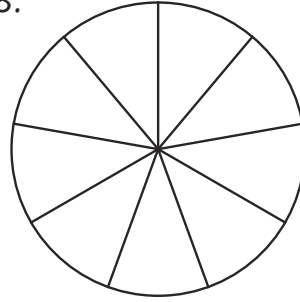

$$\frac{7}{9} - \frac{5}{9} =$$

—